

Sunnex MedicalLight®

INSTALLATION AND SERVICE MANUAL



PF Series
MRI

www.sunnex.com

TABLE OF CONTENTS

1. SHIPPING CARTON & CONTENTS.....	3
2. INTRODUCTION	4
3. PF SERIES MRI SPECIFICATIONS	5
3.1 TECHNICAL DATA	5
3.2 EMC COMPATIBILITY	6
3.3 TRANSPORTATION AND STORAGE.....	6
4. ASSEMBLY INSTRUCTIONS.....	7
4.1 PF SERIES MRI MOBILE - PF28016-M.....	7
5. OPERATING INSTRUCTIONS	13
6. SERVICE AND MAINTENANCE	14
7. MARKINGS	20
8. WARRANTY.....	21
9. TROUBLESHOOTING	17
10. APPENDIX.....	19

1. SHIPPING CARTON & CONTENTS

PF28016-M (mobile)

- One lamp arm assembly with 30 feet cord and connector
- One caster base with 5 wheels
- One base weight with 5/16-18 x 2 ½ socket head cap screw
- One vertical pole with set screw
- One electrical box with lead and cord plug
- Two Allen keys; 3/32 and 6mm (the keys are magnetic)
- Two cord hooks (off-white) to hold output cord to the pole
- A combination of installation guide/instruction manual

The electrical box is packaged and shipped with the light.

*Carefully check the contents of the shipment. Report shortages and/or errors, to Sunnex or your dealer's customer service department, within five (5) working days.

The recovery of costs related to shipping damage, concealed or otherwise, can be a long and frustrating experience. In order to avoid the uncomfortable aspects, all freight claims by either the dealer or consignee should be filed with the transportation company within five (5) working days. The carton and its inserts should be kept for inspection by the transportation company.

CAUTION: Please be aware, if this routine is not followed, and the carton and its contents are disposed of or destroyed before inspection by the transportation company, our assistance is of no value to you.

2. INTRODUCTION

The objective of this manual is to assist you in assembling your PF series MRI light, to introduce some of its most important features, and to provide suggestions for its care.

2.1 INTENDED USE

The Sunnex PF series MRI light is intended for use in MRI environments where illumination is required for various tasks around the bore. **CAUTION! This light is intended for out of bore procedures only. Any deviation or inappropriate use may result in serious injury.**

2.2 SAFETY INSTRUCTIONS

The Sunnex PF series MRI light must be operated with the safety of the user and patient in mind. Please read this manual and any other instructions before installing the equipment. Please make sure that all appropriate service staff is informed and educated on the equipment to ensure continued safety and needed maintenance. Be sure you understand the intended use of this equipment and recommended operation before attempting to install and use the equipment.

IMPORTANT!

- This light is MRI conditional and can be used as a medical task light around the bore. **NOTE!** It is extremely important that all guidelines are strictly followed to ensure safety for users and patients.
- Use the light only for its intended purpose. It is a portable medical task light intended for use outside of the bore.
- **WARNING!** The power supply contains ferrous materials. **DO NOT** bring the power supply close to the magnet (100 Gauss line). Always take the furthest route away from the magnet when moving the power supply in the MRI room.
- The power supply must be fastened to a fixed structure.
- **ALWAYS** bring the light outside the MRI room when performing any service on the light. This includes any cleaning and/or bulb replacements. Also, assemble the light outside of the MRI room.

- The safety guidelines of your MRI facility must never be compromised. If in doubt, consult with your facilities manager on proper procedures.

3. PF Series MRI Specifications

3.1 TECHNICAL DATA

Power supply:	120V - 60Hz and 230V - 50Hz
Nominal Effect:	120Vac, 60Hz, 50W - 1.5A 230Vac, 50Hz, 50W - 1.0A
Light Source:	Halogen bulb - Dichroic 13.8V/50W
Bulb Life:	2,000 hours
Light Intensity:	25,300 Lux/2,350 footcandles at 1 meter
Central Illuminance	19300 Lux
Total Irradiance	131 Watts/m ²
Color Temp:	3,420K
Color Rendering Index:	97
Total Weight:	Mobile 40 lbs / 18 kg

This product is Class I and the mode of operation is suited for continuous use. Radiated and conducted emissions testing has been completed on the PF Series lights and for compliance with IEC 60601-1-2 (2001-09) 2nd edition (EN55011:1991, Group I Class B)

This product does not produce any physiological effects that could harm a patient. The mains plug on the product is a disconnect device, a mains switch is not provided.

This product is not suitable for use in the presence of a **FLAMMABLE ANAESTHETIC MIXTURE WITH AIR** or **WITH OXYGEN OR NITROUS OXIDE**.

Information about circuit diagrams, component part lists, descriptions, is available upon request. Requests can be made to engineering department.



Technical Questions

Any technical questions can be directed to Sunnex Inc. phone +1 508 651 0009 or can be written to Sunnex Inc. Engineering Department, 3 Huron Drive, Natick, MA 01760, USA.

3.2 EMC COMPATIBILITY

Sunnex Inc.

Electromagnetic Compatibility User Information for the PF MRI Light (PF 28016-M)

WARNING: Medical Electrical Equipment needs special precautions regarding EMC and needs to be installed and put into service according to the Electromagnetic Compatibility [EMC] information provided in the accompanying documents provided in the Appendix.

WARNING: Portable and Mobile RF Communications Equipment can affect Medical Electrical Equipment.

WARNING: The equipment or system should not be used adjacent to or stacked with other equipment and that if adjacent or stacked use is necessary, the equipment or system should be observed to verify normal operation in the configuration in which it will be used.

NOTE: The EMC tables and other guidelines that are included in the Instruction Manual provide information to the customer or user that is essential in determining the suitability of the Equipment or System for the Electromagnetic Environment of use, and in managing the Electromagnetic Environment of use to permit the Equipment or System to perform its intended use without disturbing other Equipment and Systems or non-medical electrical equipment.

To avoid electromagnetic interference, guidelines in this instructions manual and guidelines of MRI **MUST** be strictly followed.

3.3 TRANSPORTATION AND STORAGE

This light is packaged in card board and should be transported protected from moisture. The light should be stored in a dry environment and room temperature.

Transportation and storage temperature: -5°F / -20°C to 140°F / 60°C

Humidity < 95%

4. ASSEMBLY INSTRUCTIONS

There are several factors involved with proper installation. Considering them will help you produce a safe work environment for yourself and your patients.

Please follow the directions for assembly carefully as any negligence or poorly performed assembly may void the Warranty. Any modification to the structure of the light may also void the listings of this product.

4.1 PF SERIES MRI MOBILE - PF28016-M



CAUTION! THE ELECTRICAL BOX CONTAINS FERROUS MATERIALS AND MUST BE HANDLED WITH CAUTION. THE ELECTRICAL BOX SHOULD BE SECURED TO A STRUCTURAL MEMBER AT A SAFE DISTANCE (100 GAUSS LINE) AWAY FROM THE MRI MACHINERY. DO NOT MOUNT BOX DIRECTLY TO SHEET ROCK OR PLYWOOD SUBSTRATES. IDEALLY, THE ELECTRICAL BOX IS SECURED BY NON-FERROUS FASTENERS OR VELCRO, DIRECTLY TO THE FLOOR OUTSIDE THE MAXIMUM RECOMMENDED GAUSS LINE.

It is recommended the electrical box is mounted away from high traffic area and congestion to avoid the possibility of damage or removal from mounting surface.

Assembly and installation of the light

IMPORTANT! Assemble the light outside of the MRI room.

1. Snap in five wheels onto caster base. It may be necessary to expand the brass clip with a screwdriver to fit the wheel in caster base (See figure 1). Take 5/16 -18 bolt (provided) and position bolt up through the weight and bottom of caster base. Attach caster base and weight to pole by threading screw into the bottom of the pole. Ensure that the weight, caster and vertical pole are attached properly.

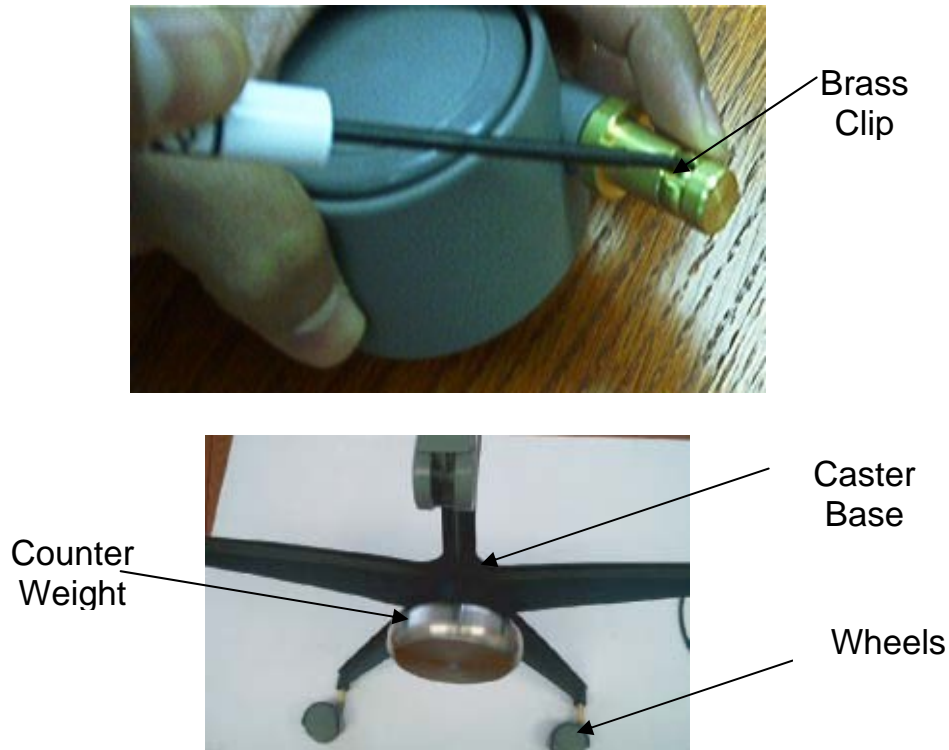

Figure 1. Installing counter weight to the caster base

2. Place lamp arm assembly into top of pole and secure in position with the set screw provided in the side of the pole.

ELECTRICAL CONNECTIONS

Option 1 – Installing the transformer box outside MRI room using RF filter

The transformer box is equipped with 30ft of cord on the secondary side and 10ft of cord on the primary side. If installing the transformer box outside the MRI room, connectors may be required on the secondary side to

accommodate the use of an RF filter. RF filter connectors will be different based on which RF filter is used. If your facility construction requires alterations beyond these guidelines, please contact Sunnex Technical Support.

WHICH RF FILTER TO USE

PF MRI LIGHT specifications:

Power Supply:	120V - 60Hz and 230V - 50Hz
Nominal Effect:	120VAC, 60Hz, 1x50W - 1.5A 230VAC, 50Hz, 1x50W - 1.0A
Voltage output:	14V DC
Current:	3.6 Amp. DC in secondary

Sunnex does not advise any specific filter but the specifications of the PF MRI product must be carefully considered when selecting a filter. Following are recommendations of filters that can be used: Spectrum Control part# 56-705-003 (this is a 9-pin D sub connector RF filter) or equivalent should be used. Some manufacturers that make RF filters are: Amphenol Canada, Spectrum Control, ERNI, Conec. The voltage drop over the filter must be minimal to ensure proper performance of the light fixture. The guidelines and requirements of your MRI facility must be considered as well. Consult with your MRI facility manager or the RF panel support technician if uncertain.

1. Mount transformer box securely to a structural member in the area close to the RF panel in the adjacent equipment room using 1/4 X 2" bolts (Four holes are provided on the base plate of transformer box). The transformer box should not be stacked with other power supply units.
2. It is recommended not to mount the transformer box on wall.
3. Velcro is provided on the base plate of the transformer box and a rope and snap-on hook is provided on the transformer box to assist in proper installation. (Velcro can be used to secure the transformer box to a flat surface and snap-on hook is provided to emphasize that the transformer box needs to be location-constrained and it can be used to secure the transformer box).
4. Select appropriate mating D sub connectors for RF filter. Cut the cord on secondary side of the light, install (solder) two wires of this cord (black = hot, white = neutral) to the selected D sub connector and install this connector to the RF filter. (CUTTING THE CORD IN SUCH A WAY

DOES NOT VOID THE WARRANTY OF THE PRODUCT AND DOES NOT VOID THE CERTIFICATION LISTING). Install (solder) wires of other end of lamp cord to the selected D sub connector for inside of the MRI room and install this connector to the RF filter from inside the MRI room. (Sunnex Inc. does not provide RF filters or the mating D sub connectors to RF filter). Sunnex Inc. can provide the output cord (Sunnex part# 50710030) or 18AWG/2 wire, temperature rating 105 degree C should be used. A typical installation is shown in following diagram. A 3-pin, 9-pin, 25-pin D Sub connector can be used.

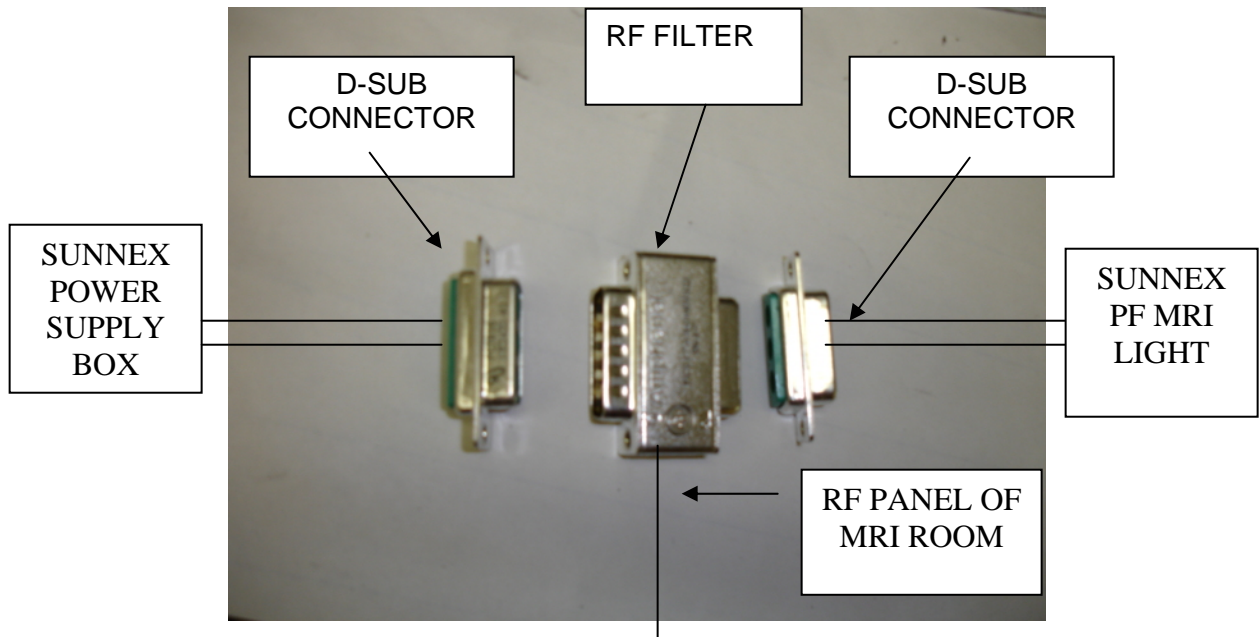

5. Plug male connector (from lamp cord) into the female connector on the electrical box. **CAUTION:** Male connector has a mechanical latch. Be sure lamp connector is fully engaged into electrical box female connector and the latch is fully engaged. (To disconnect, press tab on the female connector [and hold] and pull the male connector.)

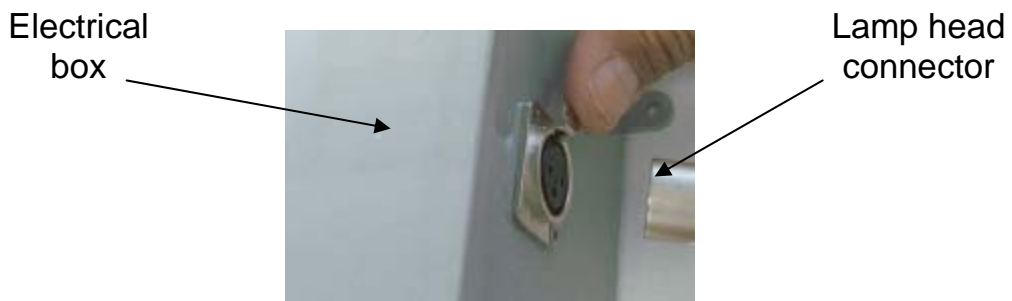

Figure 2. Lamp connection with electrical box

CAUTION	<ol style="list-style-type: none"> 1. IN CASE YOU NEED TO DETACH MALE CONNECTOR FROM FEMALE CONNECTOR OF POWER SUPPLY, YOU MUST FIRST “PUSH” ON THE TAB OF FEMALE CONNECTOR AND THEN PULL THE MALE CONNECTOR OUT. 2. PULLING THE MALE CONNECTOR FIRST, WITHOUT “PUSHING” THE TAB ON FEMALE CONNECTOR MAY MAKE THE CONNECTION TIGHT. 3. IF THE CONNECTION FEELS TIGHT, [1] PRESS ON THE MALE CONNECTOR FIRST, [2] “PUSH” ON THE TAB OF FEMALE CONNECTOR AND HOLD [3] PULL THE MALE CONNECTOR OUT.
---------	---

6. Confirm connection through the RF panel into the light fixture in the MRI room.
7. Plug electrical box lead into a hospital grade electrical socket.
8. Lamp is ready for use.

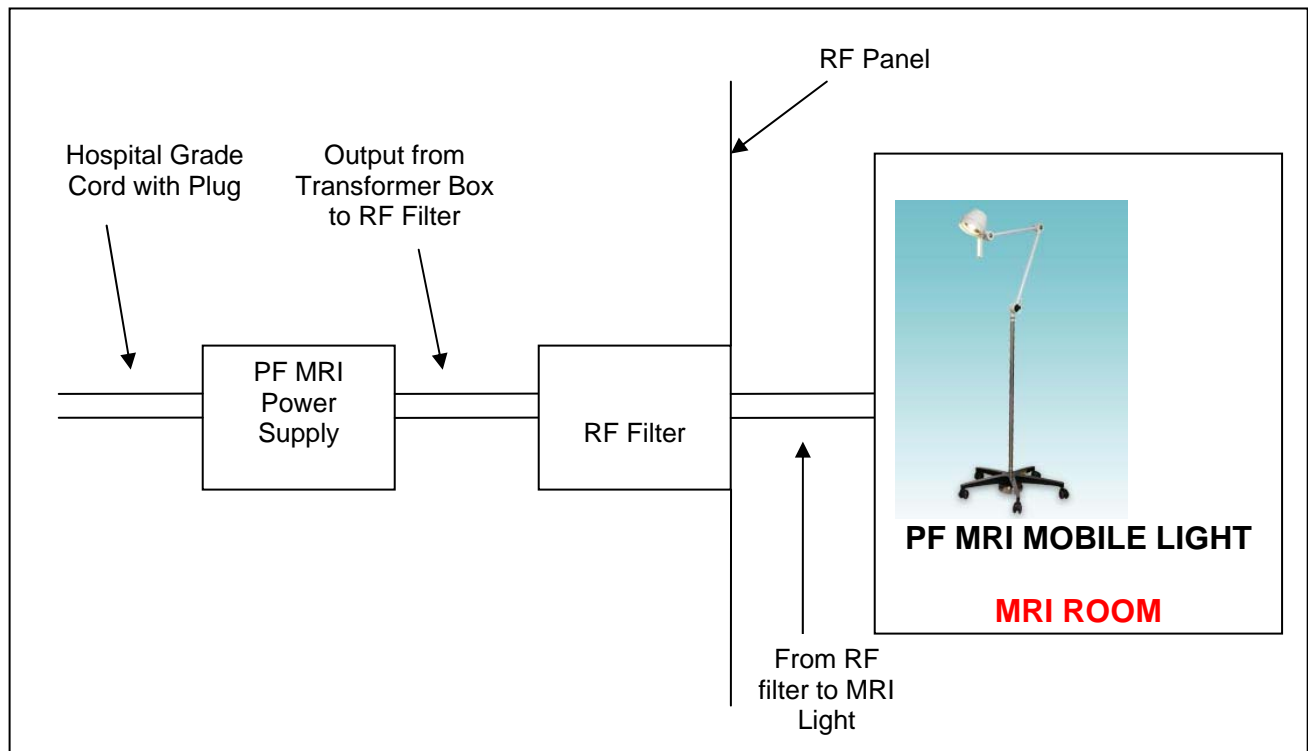

Figure 3. Schematic for option 1 (Installing the transformer box outside MRI room using RF filter)

Option 2 – Installing the transformer box inside the MRI room.

The light is equipped with 30ft of cord on the secondary side and 10ft of cord on the primary side. The total length of cord on the secondary side should not be altered from the original 30ft.

1. Mount electrical box securely to a structural member on the floor outside of the safe perimeter (100 Gauss line/10mT) of MRI machinery with a bolt 1/2" diameter x 2" L. (Four holes are provided on the base plate of transformer box).
2. It is recommended not to mount the electrical box on wall.
3. Velcro is provided on the base plate of the electrical box and a rope and snap-on hook is provided on the electrical box to assist in proper installation.
4. Plug lamp lead connector into the receptacle on the side of the electrical box. **CAUTION:** Lamp lead connector has a mechanical latch. Be sure lamp connector is fully engaged into electrical box receptacle and the latch is fully engaged. (To disconnect, press lever on the receptacle and pull the lamp head connector.)

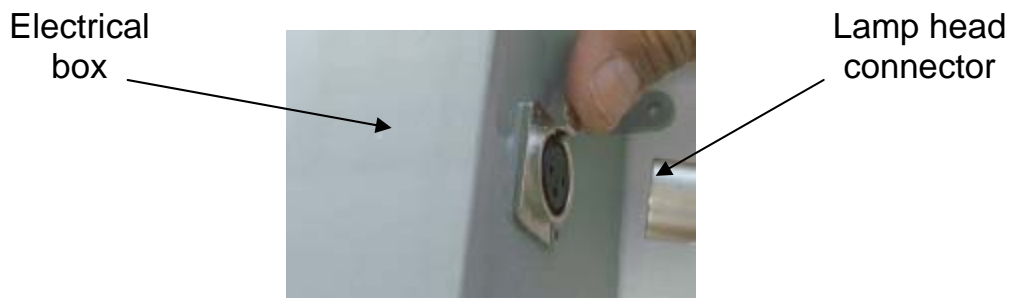

Figure 4. Lamp lead connection with electrical box

5. Plug electrical box lead into a hospital grade electrical socket.
6. Lamp is ready for use.



CAUTION! THE ELECTRICAL BOX CONTAINS FERROUS MATERIALS AND MUST BE HANDLED WITH CAUTION. THE TRANSFORMER BOX

SHOULD BE SECURED TO A STRUCTURAL MEMBER AT A SAFE DISTANCE (100 GAUSS LINE) AWAY FROM THE MRI MACHINERY. DO NOT MOUNT BOX DIRECTLY TO SHEET ROCK OR PLYWOOD SUBSTRATES. IDEALLY, THE TRANSFORMER BOX IS SECURED BY NON-FERROUS FASTENERS, DIRECTLY TO THE FLOOR/CEILING OUTSIDE THE MAXIMUM RECOMMENDED GAUSS LINE.

5. OPERATING INSTRUCTIONS

While this light is MRI compatible and can be used as a medical task light around the bore, it is **extremely** important that all guidelines are strictly followed to ensure safety for users and patients.

- This light is only intended for use outside of the bore
 - This product is not suitable for use in the presence of a FLAMMABLE ANAESTHETIC MIXTURE WITH AIR or WITH OXYGEN OR NITROUS OXIDE.
 - The installation guidelines must be strictly followed. The electrical box contains ferrous materials and must **NEVER** be placed close to the magnet. If the electrical box is moved closer to the magnet at 100 gauss line, electromagnetic interference may be seen, to avoid this **NEVER** move the electrical box close to the magnet.
 - **NEVER** operate the light while the electrical box is unsecured.
 - The lamp may slightly vibrate during its operation, but it is absolutely normal to the operation of the light.
 - It is recommended that the light be operated 3 feet away from the bore of the magnet, if the light is operated at the bore, it may reduce the bulb life.
1. Position the light fixture conveniently to illuminate the target area
 2. Position the lamp arm by adjusting the handles on the joints. The lamp arm assembly has three knobs to adjust the position of the light. Once a desired position is selected, tighten the three knobs properly to make the light stable. The lamp head can be moved 315 degrees using the handle on the lamp head.
 3. Verify that the power cord is connected to the electrical box and the electrical box is powered from the receptacle.

4. Turn on light

- The ON/OFF switch should be used to turn the light on and off. It is located at the back side of the lamp head.
- When light is not in use, turn it off, also unplug the hospital grade plug from the hospital grade socket when light is not in use. A mains switch is not provided on the electrical box.
- The PF series light, being a mobile light can be moved on its wheels by holding the vertical light pole. Before moving the light, ensure that all lamp arm joints are tightened properly.

CAUTION ! The electrical box is specifically made to run the PF series MRI light (PF 28016-M) in an MRI environment. A power supply different than this should **NEVER** be used to operate the light.

CAUTION! The caster base is weighted for stability, but the arm should not be locked in a fully extended horizontal position as this may compromise the stability of the fixture.

6. SERVICE AND MAINTENANCE

While your PF SERIES MRI light has been designed to provide you many hours of professional performance, it will benefit from your periodic care and concern. Your MRI facility guidelines must be **strictly** followed at all times. Please consult with your facility manager.

Detachable parts

Lamp head: lens cover, lens, O-ring, lens cover screws, bulb

Light assembly: light pole, light arm, caster base, caster wheels, counter weight

Electrical box: light cord connector and electrical box receptacle

CAUTION! In the event, parts need to be replaced, only Sunnex parts should be used as replacements, use of other parts or materials can degrade safety. Also, there are no user-serviceable parts in the PF series MRI light. The product should be returned to Sunnex in case service is required.

6.1 CLEANING AND DISINFECTION



CAUTION! ALWAYS BRING THE LIGHT OUT OF THE MRI ROOM PRIOR TO CLEANING OR DISINFECTING. TAKE THE FURTHEST ROUTE AWAY FROM THE MAGNET WHEN REMOVING THE LIGHT AND ITS POWER SUPPLY FROM THE MRI ROOM!



CAUTION! ALWAYS SHUT OFF THE LIGHT AND LET COOL BEFORE PERFORMING ANY CLEANING.

The lamp fixture can be cleaned as needed with a damp cloth and a mild detergent. For disinfection use a soft cloth with a disinfectant solution such as isopropyl alcohol. **NOTE!** Do not introduce any fluids to the inside of the lamp head as this could cause a fire hazard. The glass lens can be cleaned with any commercial glass cleaner.



CAUTION! DO NOT USE EXCESSIVE AMOUNTS OF ANY FLUID WHEN CLEANING. DO NOT INTRODUCE ANY FLUIDS TO THE INSIDE OF THE LAMP HEAD HOUSING.

Frequency of cleaning and maintenance: A suggested frequency for cleaning and maintenance is two months.

6.2 BULB REPLACEMENT INSTRUCTIONS PF LIGHT (PF28016-M)

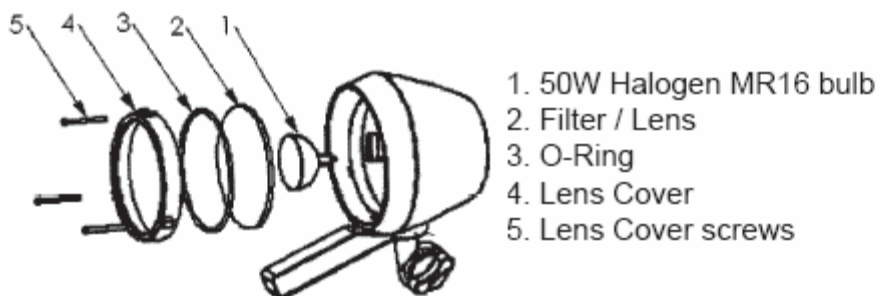

Figure 3. Bulb Replacement

It is recommended that bulb replacement be done outside the MRI room. MRI facility guidelines must be strictly followed during the use of tools to replace bulb.

1. Unplug lamp from power source and **wait at least one hour** for lamp to cool.
2. Remove the three small screws (5) and remove the lens (2), o-ring (3) and lens cover (4).
3. Grip bulb (1) and firmly pull straight out from the bulb socket on the lamp back
4. Align the pins of the new bulb with the pin holes in the bulb socket and firmly push the new bulb straight into socket. **Note! Do not touch the halogen bulb with bare fingers as dirt and oil from hands could cause a fire hazard.**
5. Reposition lampshade and components on lamp back. Position the bulb retainer that holds the bulb such that it holds the bulb properly. Align the three screw holes in the lamp back and shade. Reinstall the three screws and securely tighten them.

Bulb specifications: Osram EPZ NAED 54743, 50W, 13.8V, GX5.3

CAUTION! Use specified bulb only as the replacement, the power supply is developed to operate the specified bulb. Any deviation from using this bulb may cause the light to not operate properly.

CAUTION! Be sure the lampshade components are properly seated when screws are tightened!

6.3 FUSE REPLACEMENT INSTRUCTIONS PF LIGHT (PF28016-M)

1. Locate fuse holders (2) on the side of the electrical box. Push the fuse holder while turning it counter clockwise and remove the fuse holder from the fuse block by pulling it out.
2. Replace fuse with proper replacement fuse.
Fuse Replacement Specifications:
USA : 250V, 2A, Interpower Products – 813MDA-2
Europe: 250V, 1.25A, Interpower Products – 813MDA-1.25
3. Follow procedure in reverse to return lamp to operating condition.

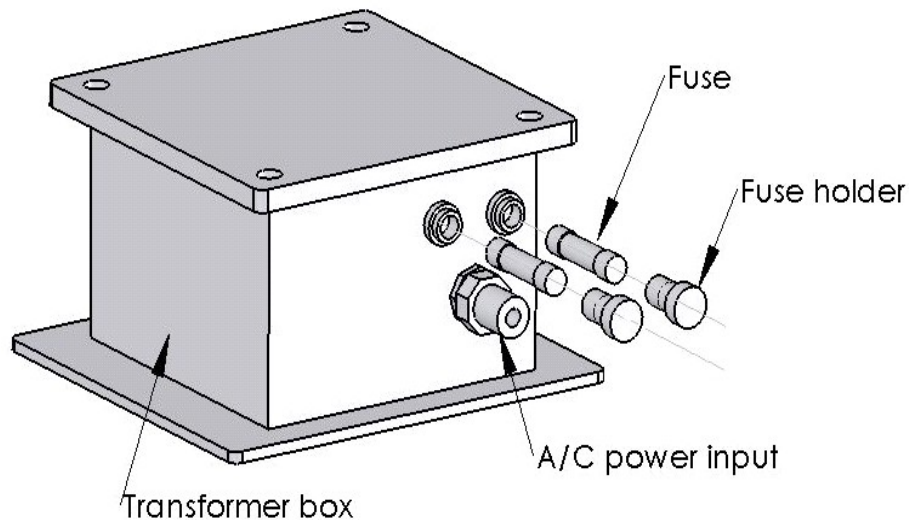

Figure 4. Fuse Replacement

6.4 PREVENTIVE INSPECTION AND MAINTENANCE

Lens in lamp head to be inspected once a month for cleanliness.

6.5 DISPOSAL OF PARTS

Bulbs/fuses: Bulbs and fuses go in normal waste. All glass parts go in normal waste.

Plastic parts: Plastic parts are to be put in recycling bins.

Transformer box: Electrical and electronic components are to be put in electrical and electronic waste.





Metal parts: Metal parts go in metal waste.





Risks associated with disposal of parts: To minimize risks associated with disposing parts, care should be taken to avoid cuts when dismantling bulbs, glass lens and other glass parts.

While disposing parts and/or product, information on local, state, federal, or country requirements need to be met.

7. MARKINGS

7.1 SYMBOLS

On/Off Switch Symbols		Caution Symbol	Protective earth terminal symbol	This product must be sorted as Waste from Electrical and Electronic Equipment (WEEE)
				
ON	OFF	Consult User Guide	Protective Earth Terminal	WEEE

Fuse Symbol	Alternating Current Symbol	Direct Current Symbol	Hot Surface Symbol
			
Fuse	A/C	DC	Hot Surface

7.2 WARNING STATEMENTS AND LABELS

On lamp head









	CAUTION!	ATTENTION!
	HOT SURFACE	SURFACE CHAUDE

CAUTION! LAMP TO BE OPERATED OUTSIDE THE BORE OF MRI MAGNET
ATTENTION! LA LAMPE DOIT FONCTIONNER UNIQUEMENT EN DEHORS DU CHAMPS MAGNÉTIQUE DE D'IRM









On electrical box

	CAUTION!
<p style="color: red; font-weight: bold; margin: 0;">THIS POWER SUPPLY IS MAGNETIC</p> <p style="color: red; font-weight: bold; margin: 0;">THIS POWER SUPPLY MUST BE KEPT BEYOND 100 GAUSS LINE OF MRI MAGNET</p>	
<p style="color: red; font-weight: bold; margin: 0;">CE TRANSFORMATEUR EST FERRO-MAGNÉTIQUE.</p> <p style="color: red; font-weight: bold; margin: 0;">CE TRANSFORMATEUR, DOIT SE TROUVER EN DEHORS DE LIGNES DES 100 GAUSS EST DU CHAMPS MAGNÉTIQUE DE D'IRM</p>	

For 120V

Sunnex	CE	INPUT 120V 
MODEL PF 28016-M		Hz 60
S/N		OUTPUT 14V 
		AMPS 1.5
		WATTS 50W
<ul style="list-style-type: none"> • FUSES LOCATED ON TRANSFORMER BOX   T-2A-250V  2 AMP, ¼" X 1 ¼" • POWER CORD IS SPECIFIED FOR USE WITH HOSPITAL GRADE RECEPTACLE • REMOVE POWER CORD FROM WALL RECEPTACLE BEFORE SERVICING 		
<hr/> <ul style="list-style-type: none"> • FUSIBLES PLACEES SOUS COUVERTURES   T-2A-250V  2 AMP, ¼" X 1 ¼" • LE CABLE D'ALIMENTATION EST SPECIFIQUE A UNE UTILISATION EN MILIEU HOSPITALIER • DEBRANCHER LE CABLE D'ALIMENTATION AVANT TOUT DEMONTAGE DE LA LAMPE 		
		SUN-6

For 230V

Sunnex	CE	INPUT 230V 
MODEL PF 28016-M		Hz 50
S/N		OUTPUT 14V 
		AMPS 1.0
		WATTS 50W
<ul style="list-style-type: none"> • FUSES LOCATED ON TRANSFORMER BOX   T-1.25A-250V  1.25 AMP, ¼" X 1 ¼" • POWER CORD IS SPECIFIED FOR USE WITH HOSPITAL GRADE RECEPTACLE • REMOVE POWER CORD FROM WALL RECEPTACLE BEFORE SERVICING 		
<hr/> <ul style="list-style-type: none"> • FUSIBLES PLACEES SOUS COUVERTURES   T-1.25A-250V  1.25 AMP, ¼" X 1 ¼" • LE CABLE D'ALIMENTATION EST SPECIFIQUE A UNE UTILISATION EN MILIEU HOSPITALIER • DEBRANCHER LE CABLE D'ALIMENTATION AVANT TOUT DEMONTAGE DE LA LAMPE 		
		SUN-7

8. WARRANTY

Sunnex warrants that its Products shall be free from defects in material and workmanship and this warranty shall remain in force and effect for a period of three (3) years from and after the date of its Delivery (the "Warranty Period") provided that this warranty shall be subject the following conditions:

(a) the Sunnex Installation Instructions shall have been strictly complied with in all respects by the party performing the installation of the Product; and

(b) the Product shall have been used only for the purposes for which it is intended and shall not have been abused, damaged or modified during installation or from usage.

(c) ordinary wear and tear shall not be covered by the terms of this warranty.

(d) written notice to Sunnex of the defective Product shall be given within the Warranty Period.

If a Product is found to be defective and the provisions of this Section have been complied with, Sunnex will repair or replace the Product, at its expense. Other than as herein expressly set forth there are no warranties made or given herein with respect to a product and the warranties given in statement are in lieu of all other warranties, which are hereby disclaimed. In particular, there are no express or implied warranties, and no warranty of merchantability or fitness for a particular purpose. Sunnex will not be liable for any special, indirect, incidental or consequential damage, loss, cost or expense whatsoever arising from the installation or use of a product or from any other cause.

When making a claim against your Sunnex warranty, please provide the model number of your product, the date of purchase and a receipt or other proof of purchase to your Sunnex customer service representative.

Sunnex Customer Service:

Sunnex Inc, USA

+1 508 651 0009

Sunnex Equipment AB Sweden

+ 46 565 177 00

9. TROUBLESHOOTING

Please refer to the following table for troubleshooting.



CAUTION! DISCONNECT THE LIGHT FROM THE POWER SUPPLY BEFORE ATTEMPTING ANY OF THE ELECTRICAL CHECKS MENTIONED BELOW.

PROBLEM	POSSIBLE CAUSE	SOLUTION
No light from light head	Light head is on OFF position	Turn on the ON/OFF switch to ON position
No light from light head, when ON/OFF switch is ON	Bulb has not been installed or it has burned out	Refer to bulb replacement procedure in the manual
	Fuse is blown	Inspect / replace the fuse following the fuse replacement procedure
	No power to the electrical box	Check for facility power to the electrical box
	Power Supply unit is malfunctioning	Call Sunnex Customer Service
	Incorrect bulb installed	Install correct bulb
Bulb burns out quickly	Incorrect bulb installed in the light head	Install correct bulb
Light output is irregular in its shape or intensity	Incorrect bulb installed in the light head	Install correct bulb
	Bulb/reflector is not seated in its holder correctly	Adjust the bulb/reflector so it seats in the holder properly.
No light from light	Circuit or wiring	Check all wiring connections.

head even when the bulb and fuse are in good condition, light head flashes intermittently when light head or arms are moved	problem within transformer, arm assemblies or other part of lighting system	If problem cannot be repaired, call Sunnex Customer Service
Various arms do not move freely at the joints	The black knob at joints is tightened too much	Adjust the black knob on joints by appropriate tightening

10. APPENDIX

Guidance and Manufacturer's Declaration — Emissions All Equipment and systems		
<p>The PF MRI Light (PF 28016-M) is intended for use in the electromagnetic environment specified below. The customer or user of the PF MRI Light (PF 28016-M) should assure that it is used in such an environment.</p>		
Emissions Test	Compliance	Electromagnetic Enforcement — guidance
RF Emissions CISPR 11	Group 1	The PF MRI Light (PF 28016-M) uses RF energy only for its internal function. Therefore, its RF emissions are very low and are not likely to cause any interference in nearby electronic equipment.
RF Emissions CISPR 11	Class B	The PF MRI Light (PF 28016-M) is suitable for use in all establishments including domestic, and those directly connected to the public low-voltage power supply network that supplies buildings used for domestic purposes.
Harmonics IEO 61 000-3-2	Complies or Not applicable	Complies
Flicker IEC 61000-3-3	Complies or Not applicable	Complies

Guidance and Manufacturer's Declaration—Immunity All Equipment and Systems

The PF MRI Light (PF 28016-M) is intended for use in the electromagnetic environment specified below. The customer or user of the PF MRI Light (PF 28016-M) should assure that it is used in such an environment.

Immunity Test	IEC 60601 Test Level	Compliance Level	Electromagnetic Environment - Guidance
Electrostatic Discharge (ESD) IEC 61000-4-2	±6kV contact ±8kV air	±6kV contact ±8kV air	Floors should be wood, concrete or ceramic tile. If floors are synthetic, the relative humidity should be at least 30%.
Electrical Fast Transient/burst IEC 61000-4-4	±2kV on AC Mains	±2kV on AC Mains	Mains power quality should be that of a typical commercial or hospital environment.
Surge IEC 61000-4-5	±1 kV Differential ±2kV Common	±1 kV Differential ±2kV Common	Mains power quality should be that of a typical commercial or hospital environment.
Voltage dips, short interruptions and voltage variations on power supply input lines IEC 61000-4-11	>95% Dip for 0.5 Cycle 60% Dip for 5 Cycles 30% Dip for 25 Cycles >95% Dip for 5 Seconds	>95% Dip for 0.5 Cycle 60% Dip for 5 Cycles 30% Dip for 25 Cycles >95% Dip for 5 Seconds	Mains power quality should be that of a typical commercial or hospital environment. If the user of the PF MRI light requires continued operation during power mains interruptions, it is recommended that the PF MRI Light (PF 28016-M) be powered from an uninterruptible power supply or battery.
Power Frequency 50/60Hz Magnetic Field IEC 61 000-4-8	3A/m	3A/m	Power frequency magnetic fields should be that of a typical location in a typical commercial or hospital environment.

Guidance and Manufacturer’s Declaration — Emissions Equipment and Systems that are NOT Life-Supporting

The PF MRI Light (PF 28016-M) is intended for use in the electromagnetic environment specified below. The customer or user of the PF MRI Light (PF 28016-M) should ensure that it is used in such an environment.

Immunity Test	IEC 60601 Test Level	Compliance Level	Electromagnetic Environment — Guidance
Conducted RF IEC 61 000-4-6	3 Vrms from 150 kHz to 80 MHz	V1 = 3 Vrms	Portable and mobile RF communications equipment should be separated from the PF MRI Light (PF 28016-M) by no less than the recommended separation distances calculated/listed below: $D = (3.5/V1)\sqrt{P}$
Radiated RF IEC 61000-4-3	3 V/m 80 MHz to 2.5 GHz	E1 = 3V/m	$D = (3.5/ E1)/\sqrt{P}$ 80 to 800 MHz $D = (7 / E1)/\sqrt{P}$ 800 MHz to 2.5 GHz Where P is the maximum power rating in watts and D is the recommended separation distance in meters. Field strengths from fixed transmitters, as determined by an electromagnetic site survey, should be less than the compliance levels (V1 and E1). Interference may occur in the vicinity of equipment containing a transmitter.

Recommended Separation Distances Between Portable and Mobile RF Communications Equipment and the PF MRI Light (PF 28016-M) Equipment and Systems that are NOT Life-Supporting

The PF MRI Light (PF 28016-M) is intended for use in the electromagnetic environment in which radiated disturbances are controlled. The customer or user of the PF MRI Light (PF 28016-M) can help prevent electromagnetic interference by maintaining a minimum distance between portable and mobile RF Communications Equipment and the PF MRI Light (PF 28016-M) as recommended below, according to the maximum output power of the communications equipment.

Maximum Output Power (Watts)	Recommended Separation Distances for the PF MRI Light (PF 28016-M)		
	150 kHz to 80 MHz $d = 1.1667 \sqrt{P}$	80 MHz to 800MHz $d = 1.1667 \sqrt{P}$	800 MHz to 2.5 GHz $d = 2.3333 \sqrt{P}$
0.01	0.11667	0.11667	0.23333
0.1	0.36894	0.36894	0.73785
1	1.1667	1.1667	2.3333
10	3.6894	3.6894	7.3785
100	11.667	11.667	23.333

www.sunnexmedical.com



Sunnex is certi
ISO9001:2000 by



Sunnex, Inc.
3 Huron Drive
Natick, MA 01760-1314
USA
Tel: + 1 800 445 7869
Fax: + 1 508 651 0099
E-mail: sales@ sunnex.com

Sunnex Equipment AB
Box 8064
SE-163 08 Spånga
Sweden
Tel: + 46 8 546 802 30
Fax: + 46 8 546 802 59
E-mail: info@ sunnex.se

Sunnex Equipement Sarl
ZI. Les Milles B.P. 154 000
13794 Aix en Provence, Cedex 3
France
Tel: + 33 442 39 78 96
Fax: + 33 442 39 78 77
E-mail: sunnex@ sunnex.fr

Sunnex GmbH
Ricarda-Huch-Str. 2
D-14480 Potsdam
Germany
Tel: + 49 331 600 77 27
Fax: + 49 331 600 77 63
E-mail: info@ sunnex.de

REV. 1.1
AUGUST 2007